

STABLOEX

Static Remover For Electronic Balances

Secure static removal

The excellent ion polarity balance achieved by the AC method ensures:

- No inverse charging
- Wide angle static removal
- High performance maintained over a long period of use

Shimadzu's unique 2-WAY Ionizer Hand-held/On stand

Air blower switched ON/OFF

Optimized operation for solid or powdered samples.

Space-saving design

Compact main unit requires a minimal space. Holder height and angle are adjustable.



► Due to static electricity.....

- Display fluctuates or drifts over a long time.

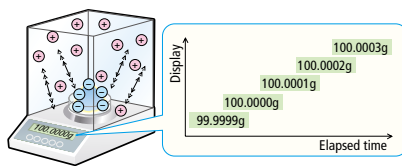

- Poor repeatability in weighed results

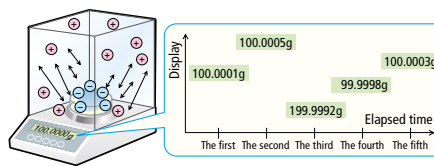

- Measurement result error

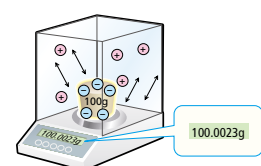

Examples of Applications



Quickly discharge container or bulk samples with fan ON.



For powdered samples, fan can be turned OFF.



As a handheld unit

Static Removal by Ion Irradiation

Weighing tends to be unstable when the sample and/or container are subject to static charging.

With the high-frequency AC corona discharge method, Shimadzu's STABLO-EX ionizer provides a stable ion balance and excellent static removal performance on samples and containers.

Precision weighing work becomes remarkably efficient. Electrodes are safely housed inside the unit.

Concept of static removal

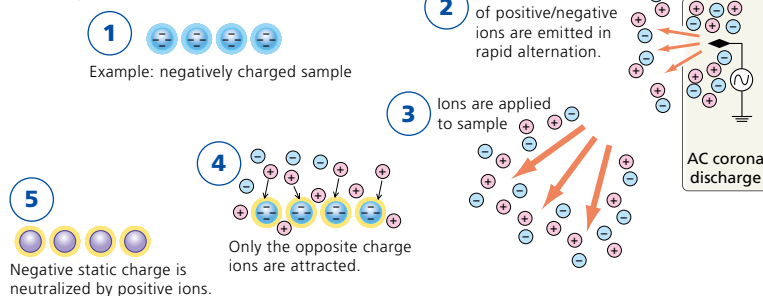

AC Method Produces Excellent Ion Balance

AC method

AC voltage is applied on the discharge needle and a well-balanced mixture of positive/negative ions is emitted in rapid alternation from one electrode.

DC method

DC voltage is applied to a couple of electrodes. One is positive and the other is negative. Each electrode emits ions of one polarity only. An effective static removal angle is limited if the two electrodes are distanced. As electrodes deteriorate, initial ion balance is lost.

AC method

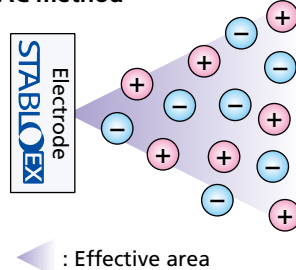

DC method

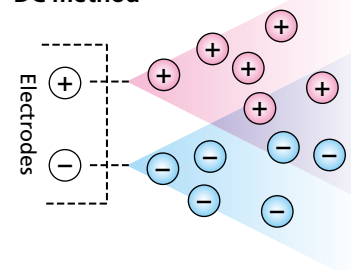

► What is "ion balance"?

Ion balance is the balance of positive and negative ions that are supplied by an ionizer.

If ion balance is poor, static is not removed or inverse charging may result.

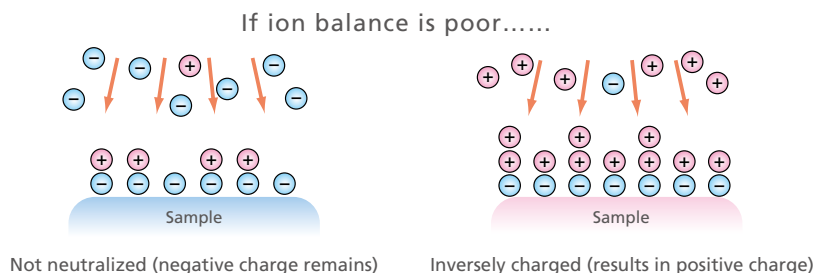

Specifications

Ion generation method	AC corona discharge method
Ion balance	± 20 V
Effective static removal range	Approx. 5 to 50 cm from electrode
Static elimination time (approx.) (from ± 1000 V to ± 100 V)	8 sec/5 cm, 12 sec/10 cm, 100 sec/50 cm (At factory shipment, fan ON)
Ozone concentration	0.04 ppm (at 2 cm from electrode)
Electrode probes	Stainless steel (SUS304, Durability: 10,000 hours)
Max air volume	0.06 m ³ /min
Weight	Approx. 540 g (Main unit: approx. 110 g, Stand: 430 g)
Operating temperature and humidity	0 to +40°C, 35 to 80% RH (non-condensing)
Power source	AC adapter (Output: DC 12 V ± 1 V, 1 A)

Physical Dimensions

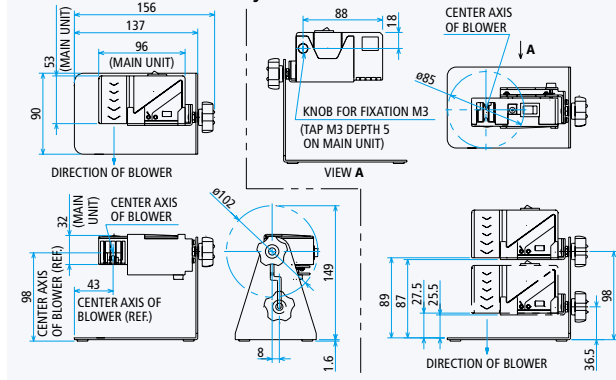

Shimadzu Corporation

www.shimadzu.com/an/

Company names, product/service names and logos used in this publication are trademarks and trade names of Shimadzu Corporation or its affiliates, whether or not they are used with trademark symbol "TM" or "®". Third-party trademarks and trade names may be used in this publication to refer to either the entities or their products/services. Shimadzu disclaims any proprietary interest in trademarks and trade names other than its own.

For Research Use Only. Not for use in diagnostic procedures.

The contents of this publication are provided to you "as is" without warranty of any kind, and are subject to change without notice. Shimadzu does not assume any responsibility or liability for any damage, whether direct or indirect, relating to the use of this publication.

© Shimadzu Corporation, 2013

Printed in Japan 3655-11306-10ANS